

Three Layers LED Pendant

PD12722
INSTALLATION SHEET

START FROM HERE

- Make sure power is completely off at the fuse box.
- Have your fixture installed by a qualified licensed electrician
- Prepare everything in a clear area.
- Wear gloves at all times during this installation.
- Read instructions carefully before you start assembly.
- Keep this instruction sheet for future reference.

Technical Support: 1-877-452-6858

Please Note:

- All Kuzco LED fixtures come with pre-wired LED module(s).
- Unless instructed to do so, please do not touch any part of the LED module(s) as any unnecessary contact with the module could cause permanent damage.
- For dimming, an ELV (Electronic Low Voltage) type of dimmer is required.

CAUTION: HEAVY FIXTURE, THE JUNCTION BOX NEEDS TO BE REINFORCED BEFORE INSTALLATION.

- 1.** Remove the fixture from its original packaging. Next, remove the canopy mounting plate (1d) from within the canopy (2a) by unthreading the two screws (2b).
- 2.** Secure the mounting plate (1d) to the ceiling with screws (1e), make sure to reinforce the wood behind the drywall. Now install the two screws (1c) provided to secure the mounting plate to the junction box (1a). Select the desired length you would like the fixture to hang down from the ceiling (120" maximum). To set the fixture hanging height, simply push in the sleeve (2c) at the canopy where the wire comes out from. Once the sleeve is pushed in you can push the wire up to shorten, or pull the wire down to lengthen. When you have selected your desired length, just release the sleeve and the wire will be held tightly in place.
- 3.** You are now ready to mount the canopy to the mounting plate. First connect all wires (1b) correctly black to black "L", white to white "N" and the ground wire with provided marrets from the hardware package. Align the mounting plate (1d) with the two holes on the surface of the canopy (2a). Next, screw in the two screws (2b) on to the mounting plate (1d), this will secure the canopy to the mounting plate, careful not to over tighten.
- 4.** You have now completed the installation of your fixture, enjoy.

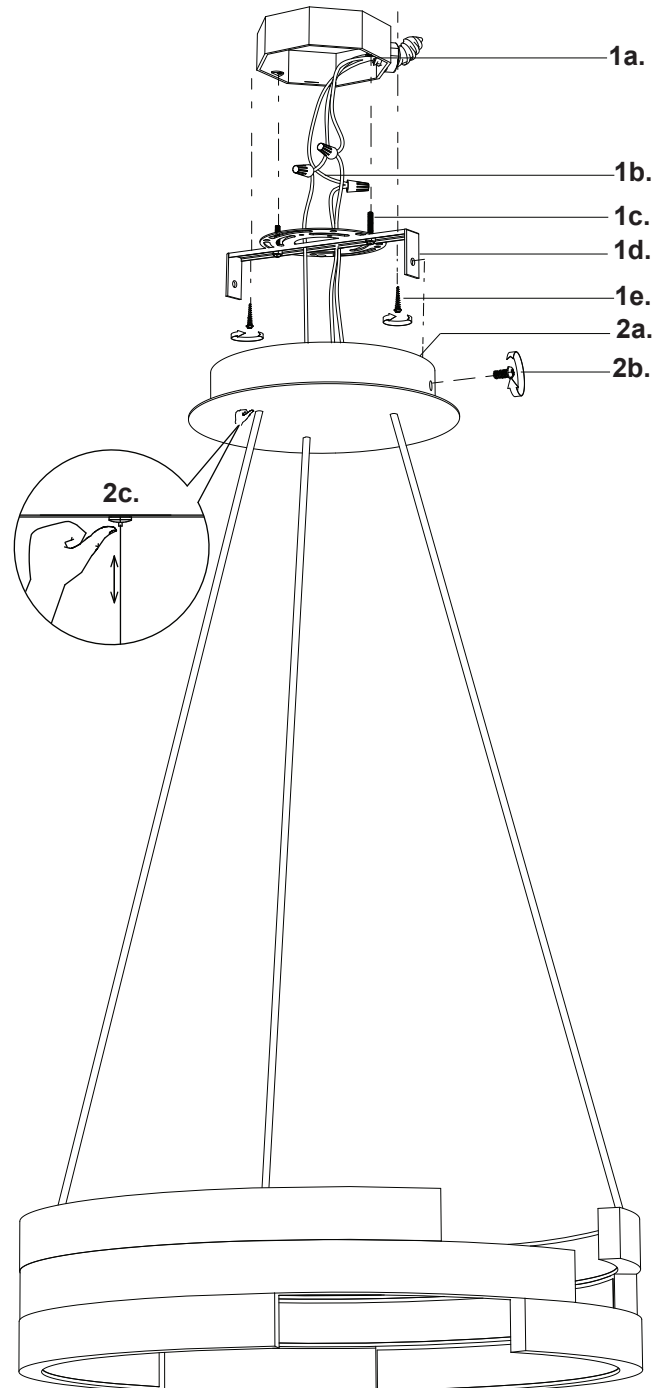

KUZCO
LIGHTING

19054 28th Avenue Surrey, BC Canada V3S 6M3
T: 604 538 7162 TF: 1-855 85 KUZCO F: 604 538 7196
W: kuzcolighting.com
20160509