

Exterior LED Bollard

EB39924
INSTALLATION SHEET

START FROM HERE

- Make sure **POWER** is **COMPLETELY OFF** at the fuse box
- Have your fixture installed by a qualified licensed electrician
- Prepare everything in a clear area
- Wear gloves at all time during this installation
- Read instructions carefully before you start assembly
- Keep this installation sheet for future reference

Please Note:

- This Kuzco LED fixture comes with pre-wired LED module(s)
- Unless instructed, Do Not touch any part of the LED module(s) as any unnecessary contact with the module could cause permanent damage
- 120~277V input
- Non-Dimming

Technical Support: 1-855-855-8926

- 1.** Remove fixture from its original package
- 2.** Dig hole 8" to 12" deep, with trench for mains power supply wires in accordance with local code
- 3.** Run mains power wires through anchor pipe (**3e**), and then place pipe (**3e**) into hole before filling with gravel or dirt
- 4.** After pipe is secured, slide anchor base (**2c**) over wires and anchor pipe (**3e**), secure set screws (**3d**) with Allen key provided
- 5.** Make proper electrical connection (black to hot "L", white to neutral "N", ground to "GND") with wire nuts (**1c**) provided in hardware package, tie access wires to avoid contact with ground
- 6.** Gently slide fixture body (**1a**) over anchor pipe (**3e**) while slide wire and wire nuts into pipe, secure onto anchor base (**2c**) with screws (**1b**) with Allen key provided

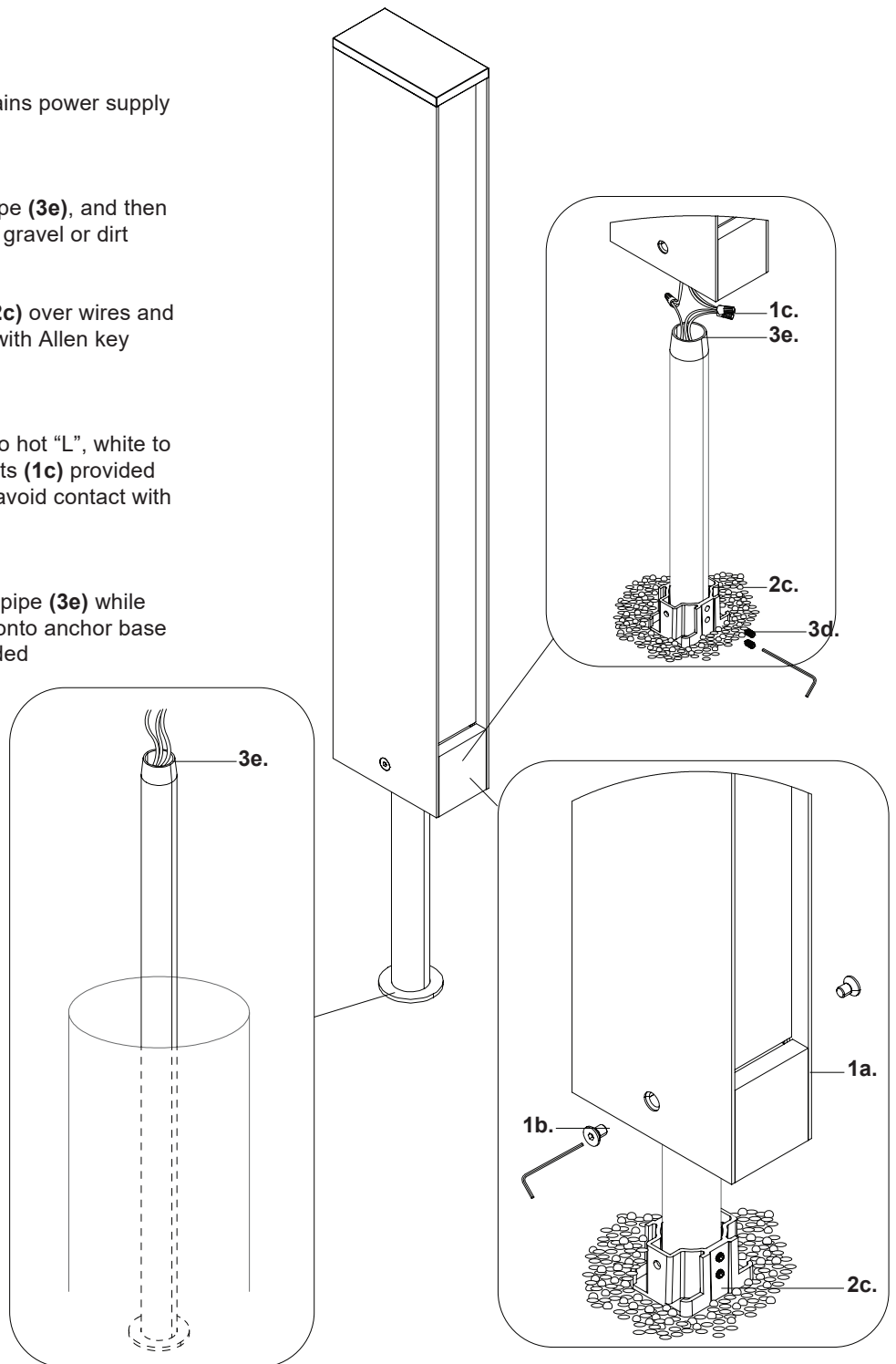

KUZCO

19054 28th Avenue Surrey, BC Canada V3Z 6M3
T: 604 538 7162 TF: 1-855 85 KUZCO F: 604 538 7196
W: kuzcolighting.com
20200611